

## GIANTMIX FT

**FT3 110-330**

**FT4 150-330**

**FT4 150-480**

**FT5 185-330**

**FT5 185-480**

**FT6 220-480**

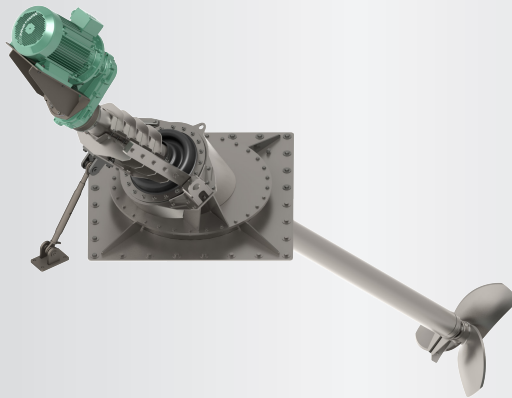



### Application

Long-axis agitator for closed tanks  
 Dry matter content up to 14 %  
 Substrate temperature up to 70°C  
 pH-value 6.5 - 8.2

### Technical Data

Tube length 13.1 / 16.4 / 18.0 / 19.7 ft  
 Tube Ø 6.3 x 0.2 in, ss304  
 inclusive robust tube within tube technology  
 Sealing plate 47.2x47.2 in (56.3x56.3), ss304  
 ss316 on request  
 Sound pressure level 75 dB(A)  
 Sealing membranes of EPDM60  
 Oil inspection glass for monitoring the tightness  
 Agitator completely manufactured in modular design  
 POM protection to minimize abrasion

### Motor

4-poles (IE3 motor)  
 60 Hz, special voltages on request  
 PTC thermistors 160°C (overheat protection)  
 Ex-Motor  II 3G Ex nA IIA T3 Gc  
 Special design 18.0 hp:  II 2G Ex e IIA T3 Gb  
 Option: rain protection hood (ss304)

### Gear

Planetary gear, helical teeth, low noise level  
 Reduction ratio  $i = 3.69$  or  $5.31$   
 Own oil circuit gear oil SAE85W-140 / API GL-5  
 Oil change all 2,000 operating hours

### Bearing

2 tapered roller bearing to absorb the axial forces  
 Mechanical seals SiC/SiC, independent of rotation direction  
 Interim bearings for the drive shaft (slide bearings)

### Propeller

3-blade high efficiency propeller, dynamically balanced



FT3:	15.0 hp	330 rpm	Propeller HD+ 660
FT4:	20.0 hp	330 rpm	Propeller HD+ 750
FT4:	20.0 hp	480 rpm	Propeller HD+ 540
FT5:	25.0 hp	330 rpm	Propeller HD+ 780
FT5:	25.0 hp	480 rpm	Propeller HD+ 580
FT6:	30.0 hp	480 rpm	Propeller HD+ 620

ss304, ss316 or hardened steel

### Tank openings

31.5 x 31.5 in (plate 47.2 in)  
 39.4 x 39.4 in (plate 56.3 in)

### Ex-Zone

Ex-Zone 2 (outside tank) and Zone 1 (inside tank)  
 Special design FT4 18.0 hp for Zone 1 (outside)  
 Classification mechanical components:  
  II 2G Ex h IIA T3 Gb

### Control switch (optional)

Soft start or frequency converter  
 Delivery without connecting cable

## GIANTMIX FT

**FT3 110-330**

**FT4 150-330**

**FT4 150-480**

**FT5 185-330**

**FT5 185-480**

**FT6 220-480**

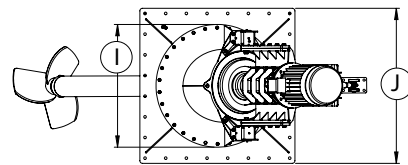
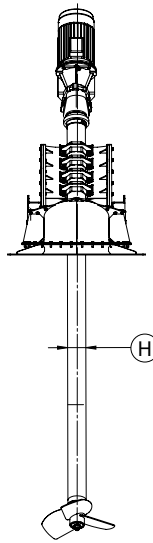
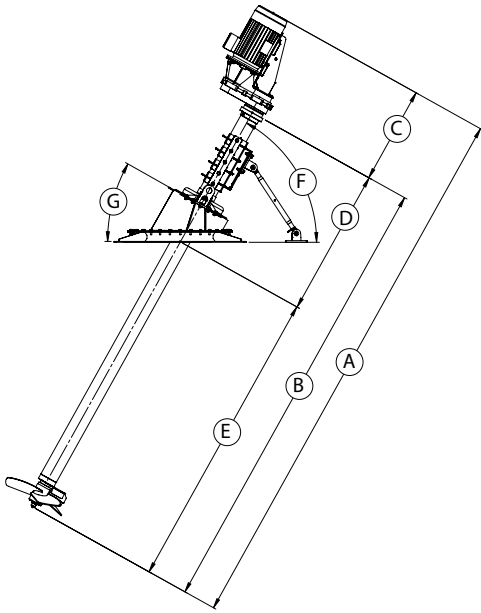

### Dimensions

Type	A [in]	B [in]	C [in]	D [in]	E [m]	F	G	H [Ø in in]	I [in]	J [in]
FT 4-6 (480 rpm)	177 / 217	157 / 197	35	53	118 / 157 / 177 / 197	max 60°	30°	6.3	ø 37	47.2
FT 3-5 (330 rpm)	236 / 256	217 / 236								56.3

### Technical data

Type	Rated Power [hp]	Propeller speed [rpm]	Frequency [Hz]	Gear reduction ratio	Propeller diameter [in]	Axial force [lbf]	Flow velocity [ft/s] *	Pumping rate water [gal/min]	Weight approximate [lbs]
FT3	15.0	330	60	5.31	26.0	517	10.8	16,642	1,873
FT4	20.0	330	60	5.31	29.5	696	12.1	24,832	1,873
FT4	20.0	480	60	3.69	21.3	606	13.8	14,529	1,873
FT5	25.0	330	60	5.31	30.7	764	12.1	27,209	1,873
FT5	25.0	480	60	3.69	22.8	719	13.5	16,378	1,873
FT6	30.0	480	60	3.69	24.4	854	13.8	19,284	1,873

Subject to technical changes

\* measured in water and 1.2 m distance