

GDD

GASTIGHT CEILING LEAD THROUGH

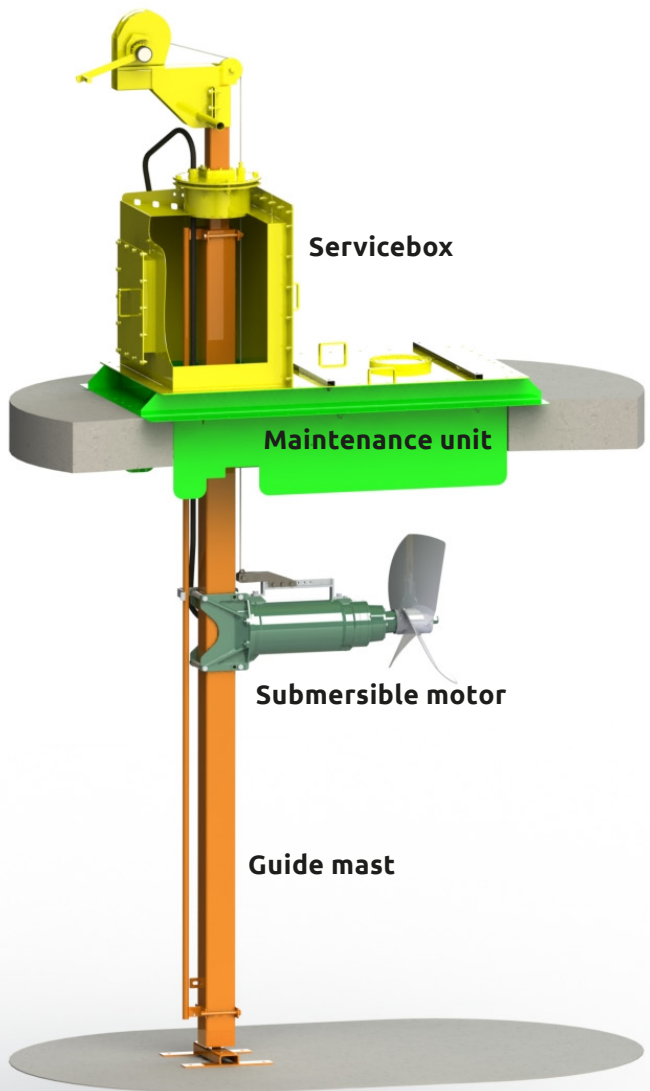

Application

Gas tight maintenance and service hatch for installation on hardened ceilings on tanks up to 53' height (larger heights on request)

Gas pressure 50 mbar (higher pressures on request)

For use with all OPTIMIX units

Service box

For mounting on the maintenance unit or directly to top of hardened tank ceiling

Tank opening 66.9" x 35.4" (other sizes on request)

Stainless 316 sealing plate with sight glass, wiper and flushing unit

Lateral adjustment 360 degrees

Stainless 304 cable winch with stainless 316 cable (max. load 1900 lbs)

For use with 4" x 4" | 6" x 6" stainless 316 guide masts

Components

Service box

Maintenance unit

Submersible motor

Guide mast

Maintenance unit (optional)

Stainless 316 base frame in various sizes

Maintenance flaps for closing the tank during service and maintenance work

Height indication

Height indicator for submerged mixer

Mounted on the cable winch

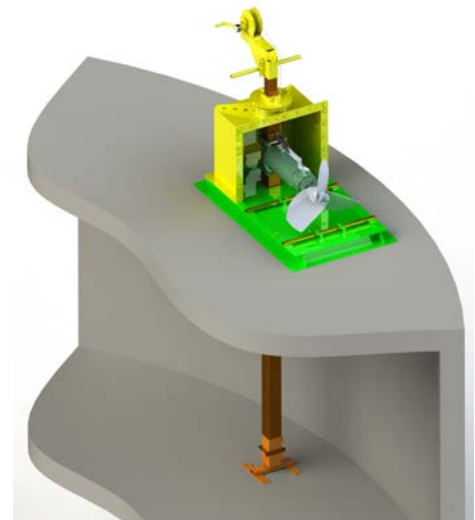
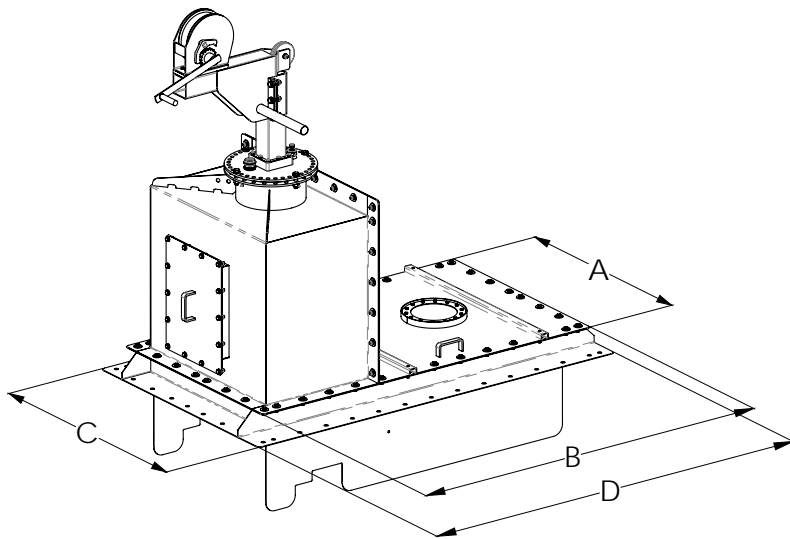

Standard dimensions

Description	A [in]	B [in]	C [in]	D [in]	Opening width [in]	Opening length [in]	Flatness concrete [in]
Servicebox (sealing plate)	42.0	76.6			35.4	66.9	0.12
Option: Maintenance unit (box with cover)			48.4	79.9			

Custom solutions and sizing on request

Subject to changes without notice
As per: 2021-04

© SUMA America Inc. | 2700 Patriot Blvd Suite 250 | Glenview, IL 60026
Tel: (312) 945 9049 | E-mail: sales@gosuma.com | www.gosuma.com